

VARIABLE DISPLACEMENT VANE PUMP



VP-SF-12/20



VP-SF-30/40-10



VP-SF-30/40-20

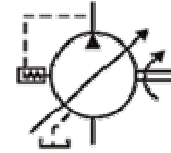

HOW TO ORDER:

VP - SF - 20 - B - 10

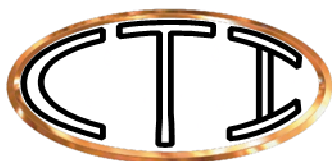
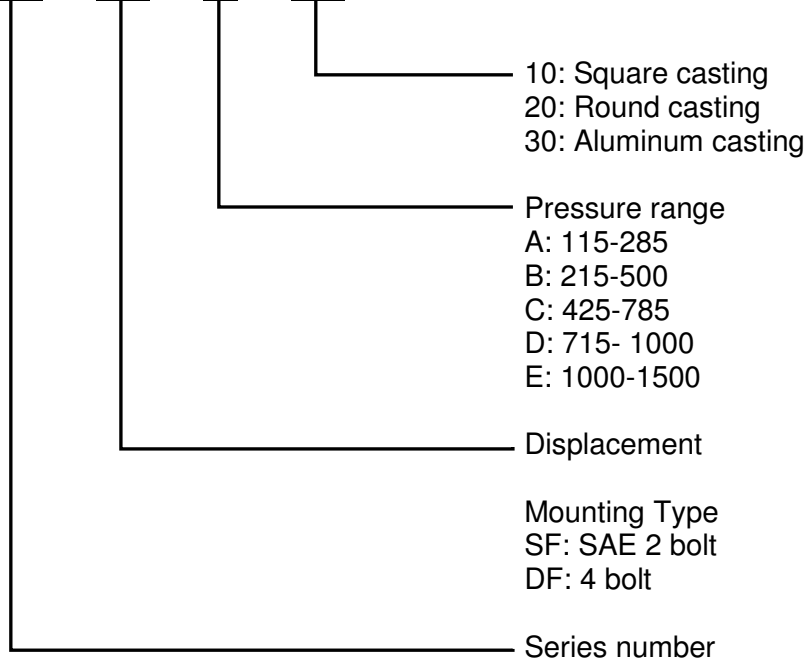

Control Technologies International

519 823 4466

www.c-t-i.ca

Technical Data

MODEL	Delivery at on load L/min		Pressure Range psi	Shaft Speed rpm		Max Pressure psi	Weight lbs Flange
	1800rpm	1500rpm		Max	Min		
VP-SF-12-A	12	10	115-285	1800	800	285	11
VP-SF-12-B			215-500			500	11
VP-SF-12-C			425-785			785	11
VP-SF-12-D			715-1000			1000	11
VP-SF-12-E			1000-1500			1500	11
VP-SF-20-A	20	17	115-285	1800	800	20	11
VP-SF-20-B			215-500			35	11
VP-SF-20-C			425-785			55	11
VP-SF-20-D			715-1000			70	11
VP-SF-20-E			1000-1500			105	11
VP-SF-30-A	30	25	115-285	1800	800	285	20
VP-SF-30-B			215-500			500	20
VP-SF-30-C			425-785			785	20
VP-SF-30-D			715-1000			1000	20
VP-SF-30-E			1000-1500			1500	20
VP-SF-40-A	40	35	115-285	1800	800	285	20
VP-SF-40-B			215-500			500	20
VP-SF-40-C			425-785			785	20
VP-SF-40-D			715-1000			1000	20
VP-SF-40-E			1000-1500			1500	20



Control Technologies International

519 823 4466

www.c-t-i.ca

VP-SF-12- ※/20- ※

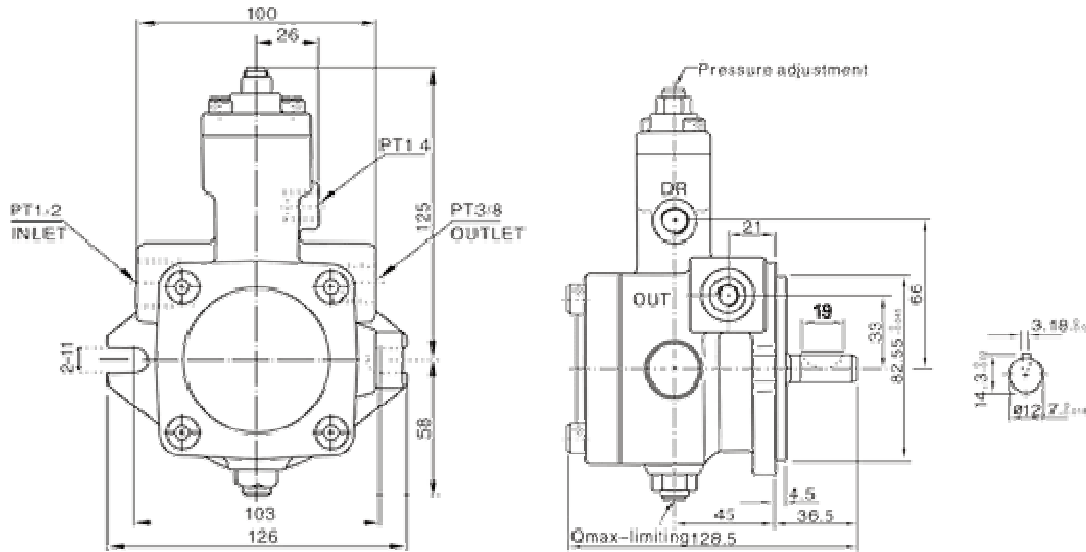

VP-SF-30- ※/40- ※-10

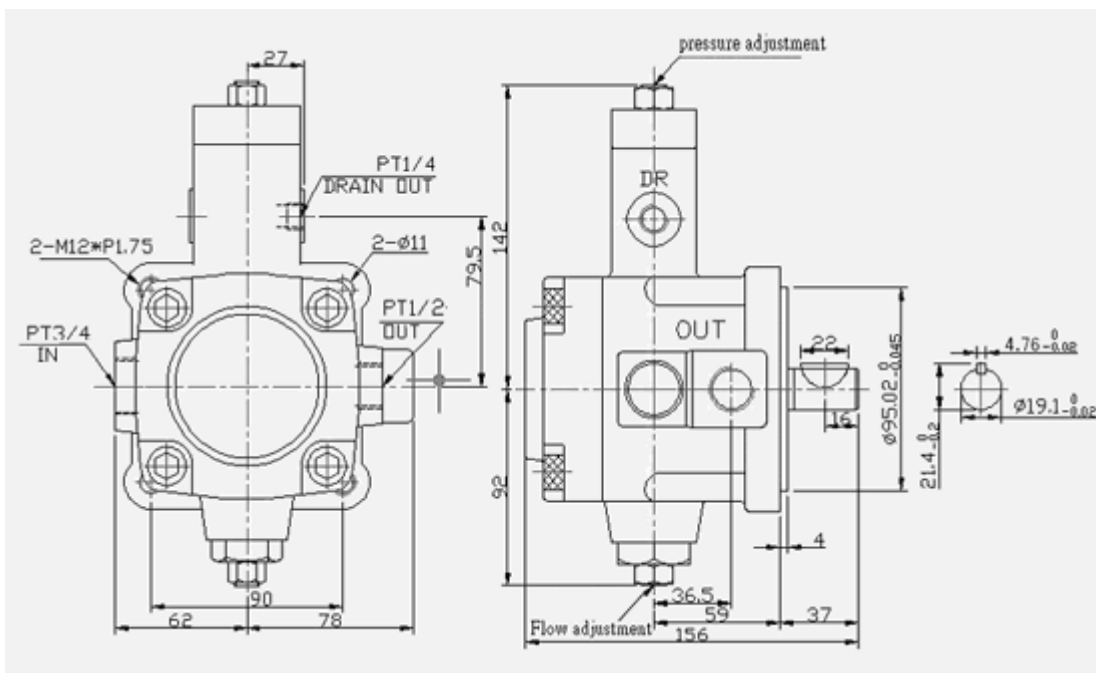

Control Technologies International

519 823 4466

www.c-t-i.ca

VP-SF-30-※/40-※-20

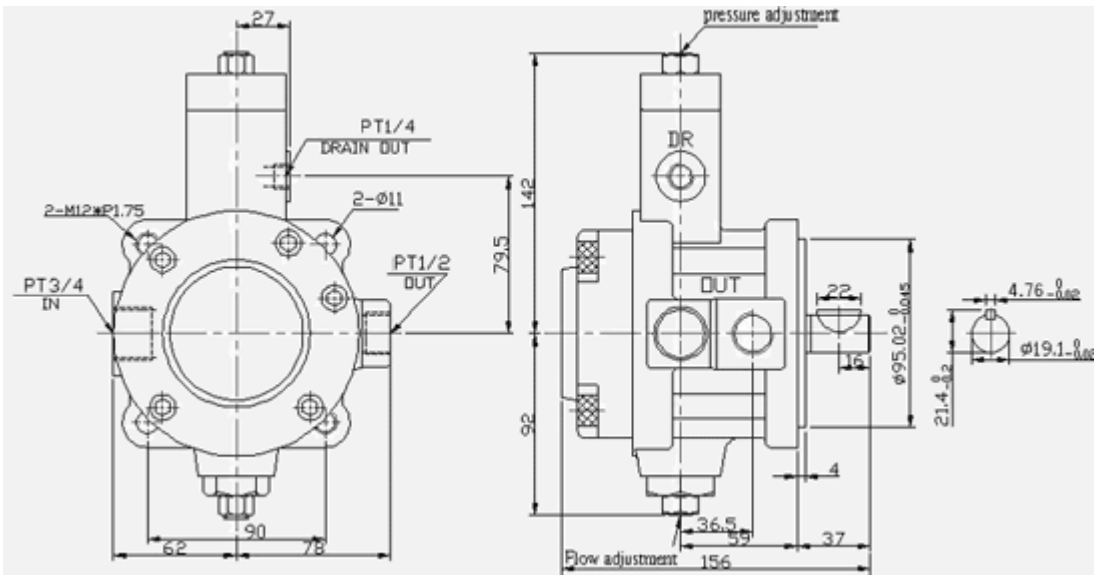

Performance Curve

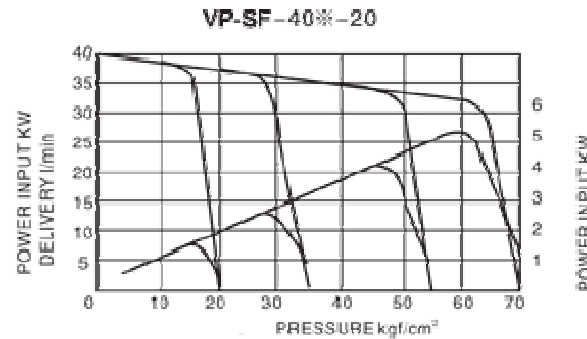
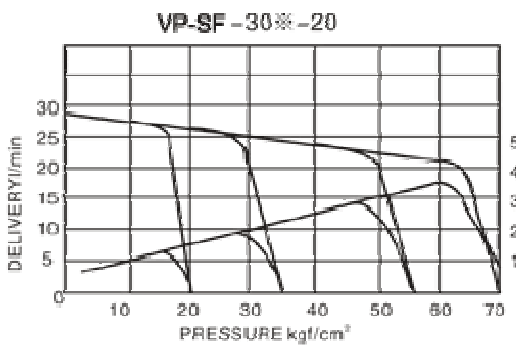
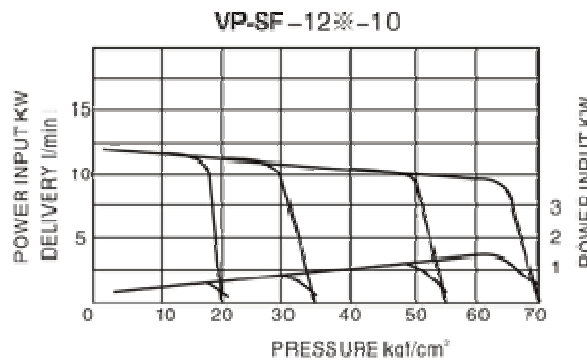
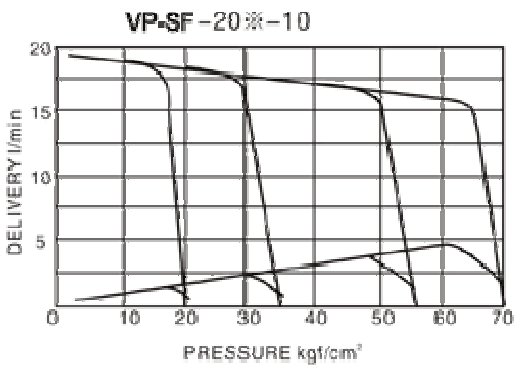

Control Technologies International
519 823 4466
www.c-t-i.ca